

Project :

Model # :

Item # :

Qty :

Approval :

Medium Profile Coil

Model : MLD308BE



≡ FEATURES / BENEFITS ≡

■ Feature

- More space in the electrical cavity
- Electrical board is now facing forward for easy installation and servicing.
- All wiring (solenoid and motor) is now located in the bottom of the unit for easy access.
- Charge nipple provided for suction pressure measurement.
- Aluminum case are now powder coated for corrosion protection.
- FAN GUIDE GRILL provided for air throw extension.
- Drain pan hinged on rear for easy access and applied double drain pan for thermal efficiency.

■ Front Access with More Space

- Design features easy front access to both electrical and refrigeration components.
- More space in the electrical cavity makes the unit easier to service and install.
- Front facing electrical control board.

■ Wiring

- Solenoid harness is standard
- Motor and solenoid harnesses are attached to sheet metal panels and are now located at the bottom of the unit for easy access.
- Holes in the bottom of the sheet metal panels for easier wire routing.
- Easy plug connectors for motor harness.

■ Heaters & Coil

- Coil heater slots have been enlarged for easier installation and replacement.
- Fixed defrost termination and adjustable defrost cycle on electric defrost.

Medium Profile Coil

Model : MLD308BE

MLD Electric Defrost Models 60Hz. With EC Motors. 4FPI

LED Model	Capacity BTUH/Watts 10°F/6°C TD -20°F/-29°C SST	Fan Data		EC Motor Data			Defrost Heater (Total Amps)		
		CFM	No.	208-230V 1Ph 60Hz			Watts	230/ 1/60	230/ 3/60
				HP	Total Amps	Watts			
MLD308BE	30857	7310	3	1/3	7.20	750	4200	18.3	19.3

LED Model	Connections (Inches)				Approx. Net Wt, LBS
	Coil Inlet	Suction	External Equalizer	Drain	
MLD308BE	7/8 OD	1-3/8 OD	1/4 OD	3/4 MPT	181

Design and specifications subject to change without notice

- **WARRANTY :** 1 Year Compressor Warranty (4 Year extended warranty available)
- 1 Year Fan Motor and Parts Warranty

PLAN VIEW

(unit : inch)

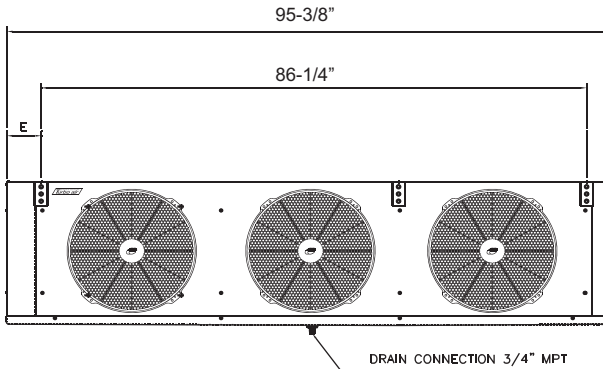

FRONT VIEW

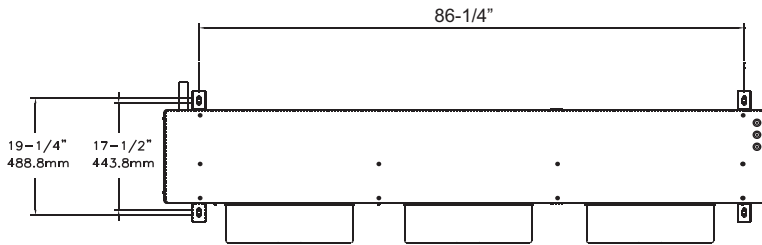

TOP VIEW

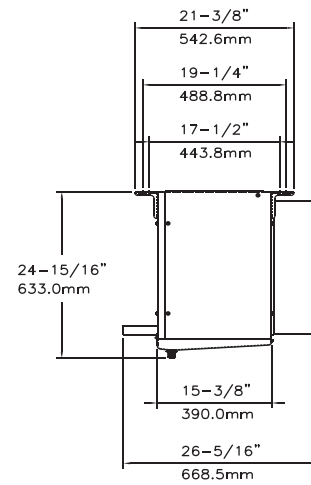

SIDE VIEW



■ Toll Free : 888-900-1002

Turbo air REFRIGERATOR MANUFACTURER

BTI BAKE TECH INNOVATION

Turbo air REFRIGERATION SYSTEM

Continued product development may necessitate specification changes without notice.